

Window with Nail Fin & House Wrap Installation Guide

IG-001 REV. 12/23 1.9



Luxury

Scan Here for a Digital Version of the
Installation Guides in English.

Quartz Luxury Windows & Doors:
www.quartzluxurywindows.com

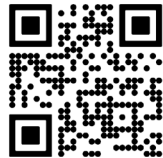

Residential

Scan Here for a Digital Version of the
Installation Guides in English.

Quartz Residential Windows & Doors:
www.quakerresidentialwindows.com



Commercial

Scan Here for a Digital Version of the
Installation Guides in English.

Quaker Commercial Windows & Doors:
www.quakercommercialwindows.com



Para ver las instrucciones en Español, escanea aquí.

If this set of instructions does not match your installation method or the wall conditions of the job site, please check our website listed below for other options, or call Quaker Customer Service for additional information.



Quaker Window Products
504 U.S. Hwy 63 South
Freeburg, MO 65035
(800) 347-0438
www.quakerwindows.com



Window with Nail Fin & House Wrap Installation Guide

Read these instructions completely before starting any installation. Failure to install and maintain our product according to these instructions may void any product warranty. These are generic instructions intended to cover most common situations, which may not be appropriate for all installations due to building design, construction materials, or methods used and/or building or site conditions. Please visit our website at www.quakerwindows.com or call 1-800-347-0438 for additional information. Inspect all units for any damage or defects prior to installation.

Tools required by installer:

Safety Glasses		Utility Knife	
Drill/Driver		Caulk Gun	
Level		Tape Measure	
Hammer		J-Roller	
Putty Knife		Staple Gun	
Phillips #2 Screwdriver			

Materials required by installer:

Foam Backer Rod		Minimally Expanding Spray Foam	
Shims (waterproof)		Sealant	
Flashing Tape (Self-Ahering)		Water Resistant Barrier/House Wrap (WRB)	
		IPA alcohol	
Fasteners		#6 x 3/4" Self tapping screws	

WARNING

Tools

- Follow manufacturer's instructions for safe operation of tools, and ladders/scaffolding. Always wear safety glasses. Failure to do so could result in injury, product or property damage.

Handling

- Do not store units outside, or in a hot environment. Doing so could result in product damage.
- Do not carry flat.** Doing so could result in product damage, injury, or property damage.
- Stack units as straight as possible to avoid bowing. **Do not lay flat!**

Glass

- If broken, glass can fragment causing injury. All Quaker products are available with safety glass. In many areas, local building codes require safety glass in certain locations and/or applications. Unless safety glass is ordered, Quaker windows are not provided with safety glass. Consult your local building codes for more definitive information.

Fastening

- Metal fasteners and components could corrode when used with preservative-treated lumber. Use approved fasteners and components to fasten window or door. Failure to do so could cause a failure resulting in injury, product or property damage.
- Fastener must attach to a structural framing member with 1 1/2" minimum fastener embedment, or minimum 3 full threads with a minimum 5/16" head as products were tested with.
- Quaker does not supply anchorage/fastener calculations, and is not responsible for determining structural adequacy of the anchorage and fasteners used to install our products, or the openings into which they are installed.**
- Do not** over drive screws or nails. Doing so could result in product damage.

 **CAUTION**
Installation

- Maintain a minimum of 1/4" between the window or door frame and exterior finish materials. Failure to do so could result in product or property damage.
- Nailing flanges and drip caps (integral or applied) **do not** take the place of window flashing. All windows and doors must be properly flashed and sealed with material compatible sealant for protection against water and air infiltration around the entire perimeter. Failure to do so could result in product or property damage.
- **Do not** set window directly on sill plate. Place shims under the side jambs. Window or door must be properly shimmed. Failure to do so could affect operation and product performance and could result in product damage.
- Live or dead loads transferred into our product can affect functionality, damage frame joinery or cause glass failures. Dead loads such as upper levels, roof, etc. Should be constructed before window or door is installed.
- Loads shall be designed to withstand the most critical effects of load factors and load combinations as required by the building code. (Loads are including but not limited to Live, Dead, Collateral, Auxiliary, Thermally induced, Seismic, etc.)
- Maximum vertical deflection of the header under all Load combination should not exceed 1/8".
- **Do not** drill through or into window sill to install alarm wires.

Sealing

- Follow instructions of foam, sealant, and flashing manufacturers regarding safety, material application, compatibility, and periodic maintenance for continued weather resistance of their products. Failure to do so could result in product or property damage. **DO NOT** overfill between the frame and opening.
- Minimally expanding foam insulation must be compliant with AAMA 812-19.
- Quaker recommends 100% silicone (ASTM C920 compliant) neutral cure only sealant. Always clean all areas where sealant will be applied. Failure to do so could result in product or property damage.
- Flashing tape must meet ASTM-D779 performance requirements.

Joining

- Do not join any window or door to any window or door not designed for joining. Joined windows and doors must be individually supported in the opening. Failure to do so could affect operation and product performance and could result in product or property damage.

Cleaning

- Acid solutions used for cleaning will damage glass, fasteners, hardware, and metal flashing. Protect these products and follow cleaning products manufacturers instructions. If acid contacts the window or door, wash all surfaces immediately with clean water.
- **Do not** use razor blades to clean glass surface. Glass damage could result.
- Clean glass using liquid glass cleaner.
- Clean frame, sash, panels, and insect screens using mild detergent and warm water with a soft cloth or brush.

IMPORTANT

- Buildings constructed prior to 1978 could contain lead paint which could be disturbed during window or door replacement. For more information on proper management of lead paint, go to: www.epa.gov/lead
- Care must be taken to properly recycle or dispose of old materials. Any recyclable materials should be separated from non-recyclable or hazardous materials. Please consult with local or state authorities regarding proper disposal of non-recyclable or hazardous materials

 **WARNING:** This product can expose you to chemicals including titanium dioxide or methanol, which are known to the State of California to cause cancer and birth defects or other reproductive harm. For more information go to www.P65Warnings.ca.gov.

 **WARNING:** Drilling, sawing, sanding or machining wood products can expose you to wood dust, a substance known to the State of California to cause cancer. Avoid inhaling wood dust or use a dust mask or other safeguards for personal protection. For more information go to www.P65Warnings.ca.gov/wood.

1

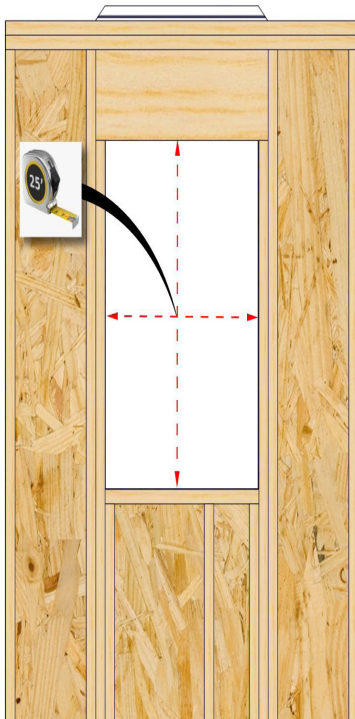

Measure and verify the opening is sized correctly. The rough opening should be a minimum 1/2" (but not to exceed 1") wider and taller than the unit. Allow additional space for flashing thickness, installation clips, joining components, and their fasteners.

2

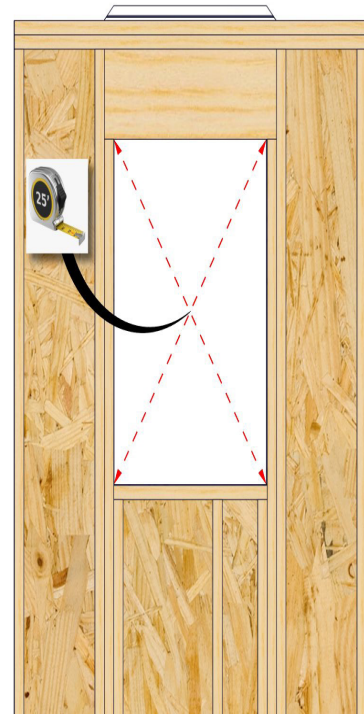

Check that the opening is square. The diagonal measurements need to be within 1/8" of each other.

3

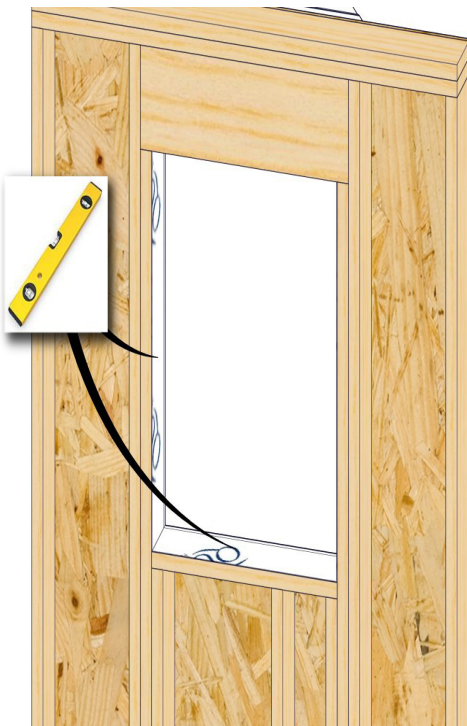

Verify the rough opening is plumb and level. The sill plate beneath the unit must be level for proper unit operation.

4

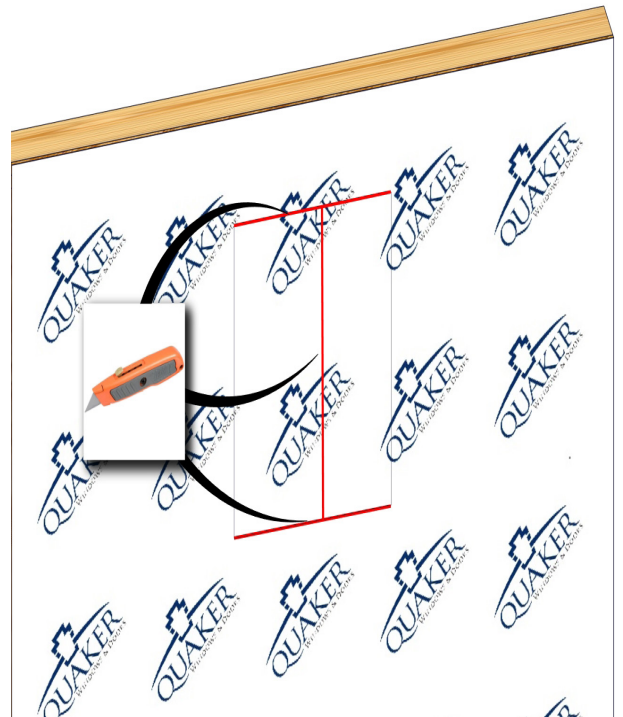

Apply the house wrap according to the manufacturer's installation guide.

5

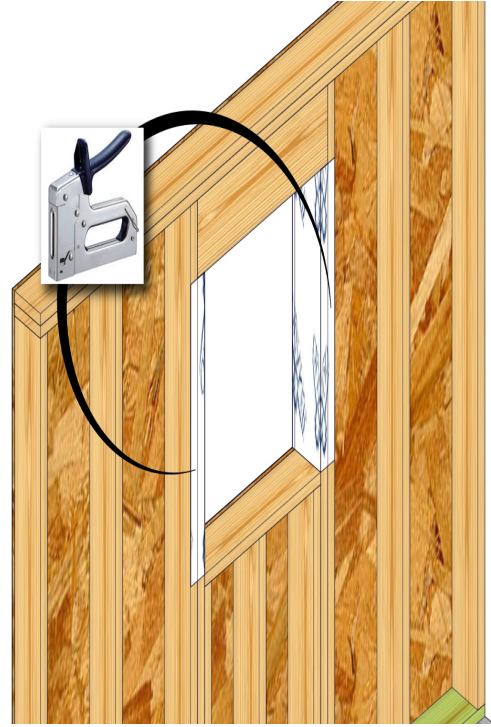
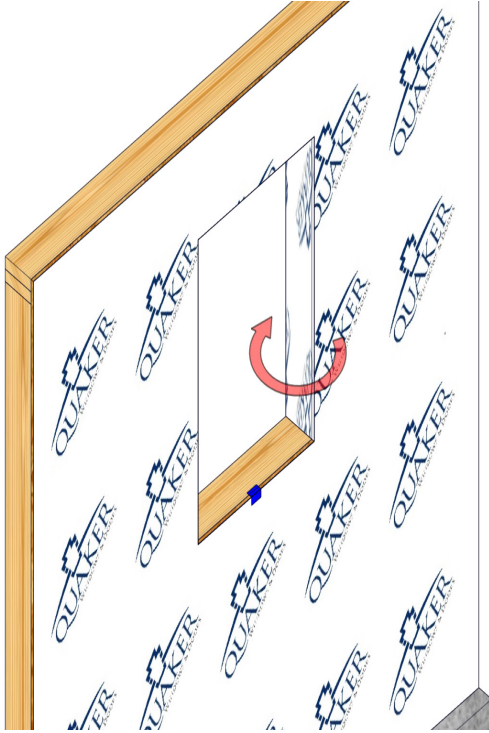

Fold the house wrap to the interior and staple it to the interior framing. Tape the house wrap at the bottom of the opening as shown.

6

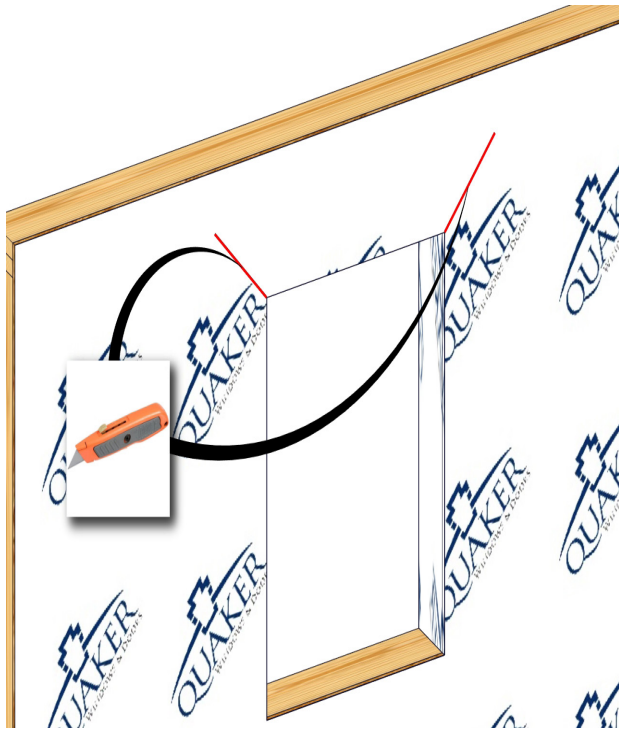

Cut the house wrap to create a top flap as shown. Cut the angles at 45 degrees and 1" longer than the width of the flashing tape being used.

7

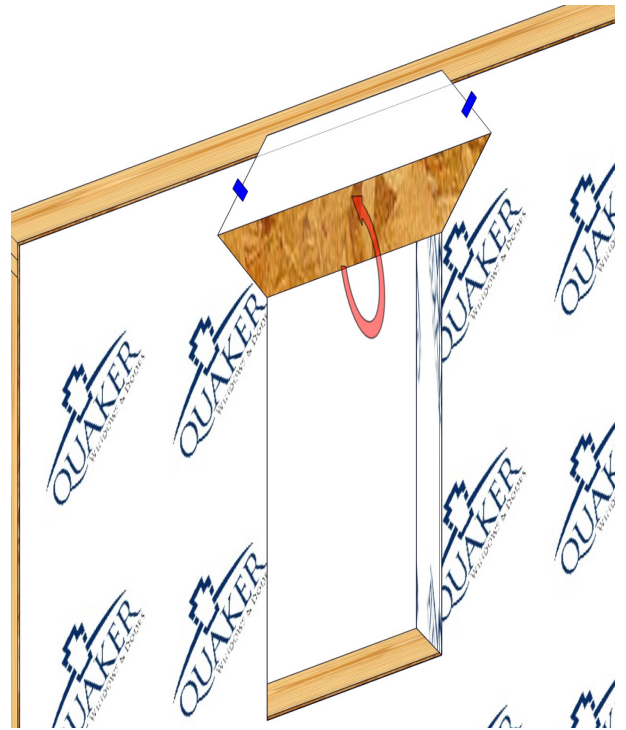

Fold the house wrap flap up and temporarily tape it in place.

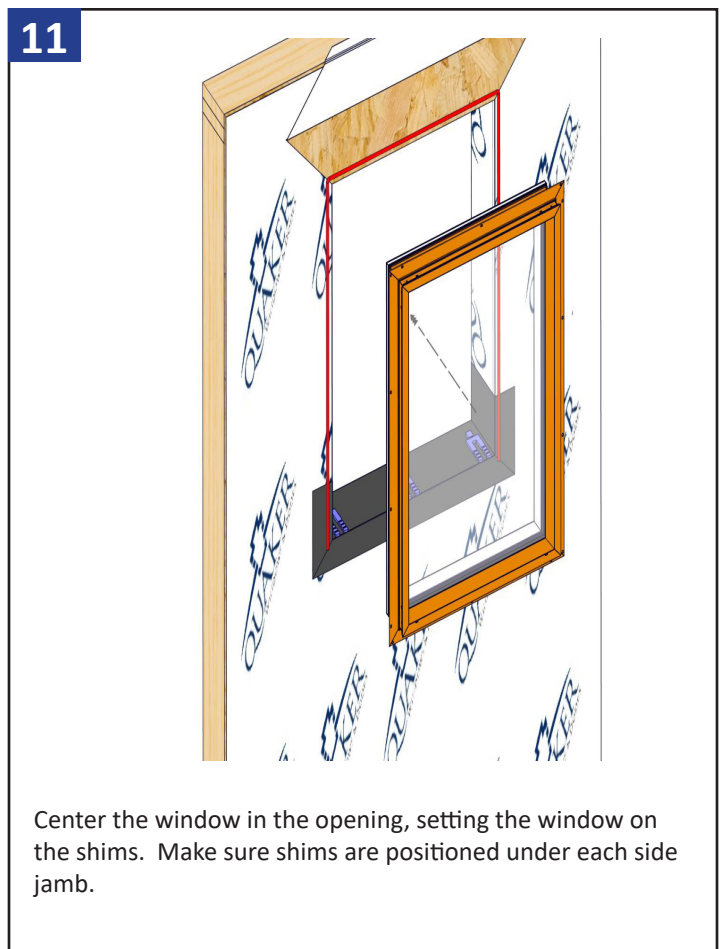
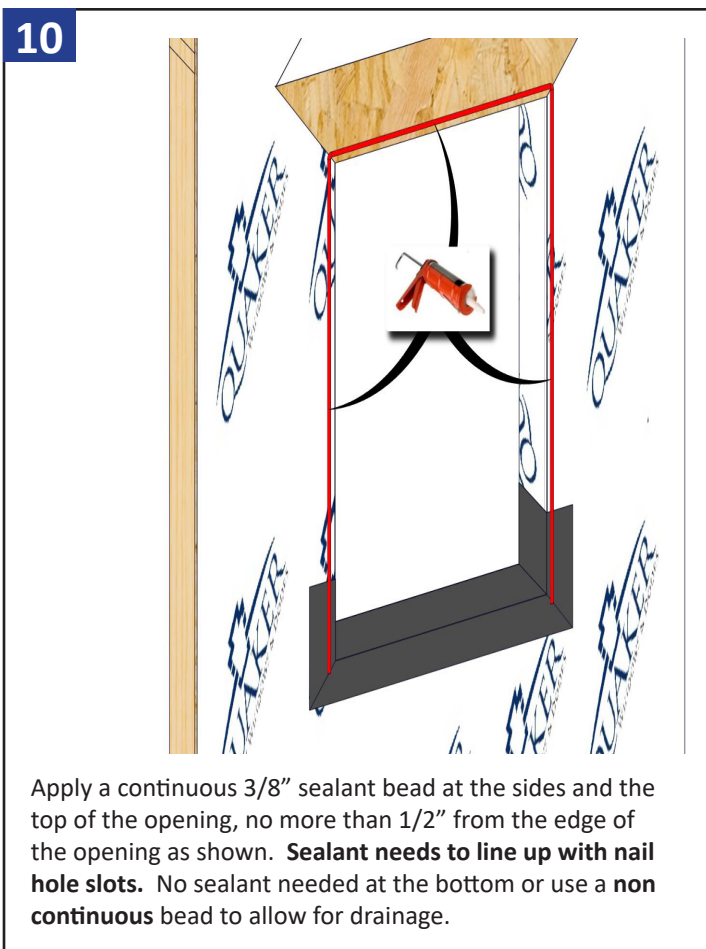
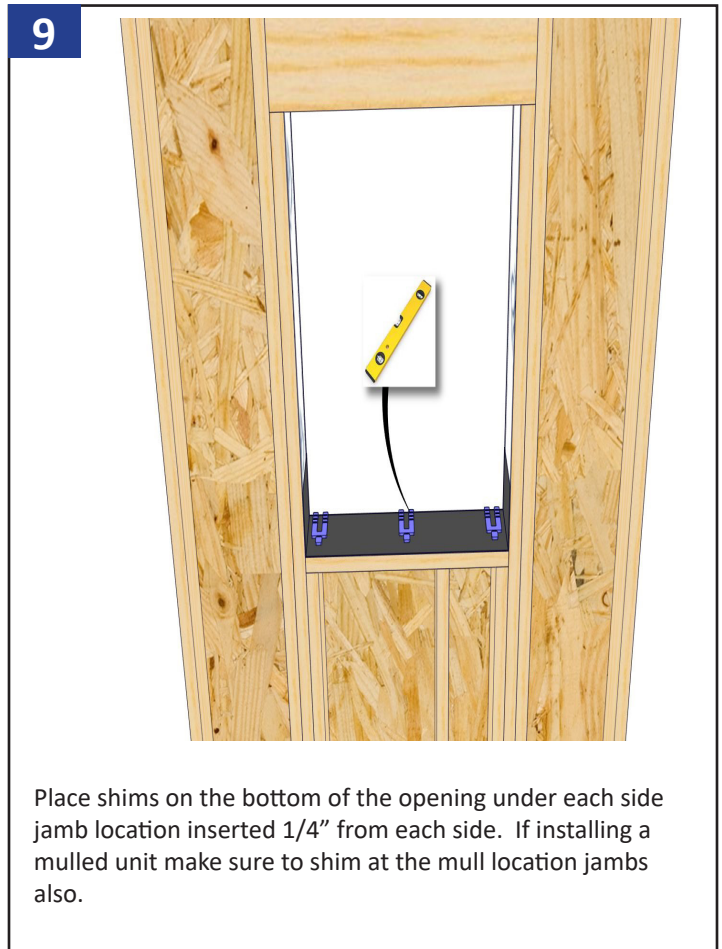
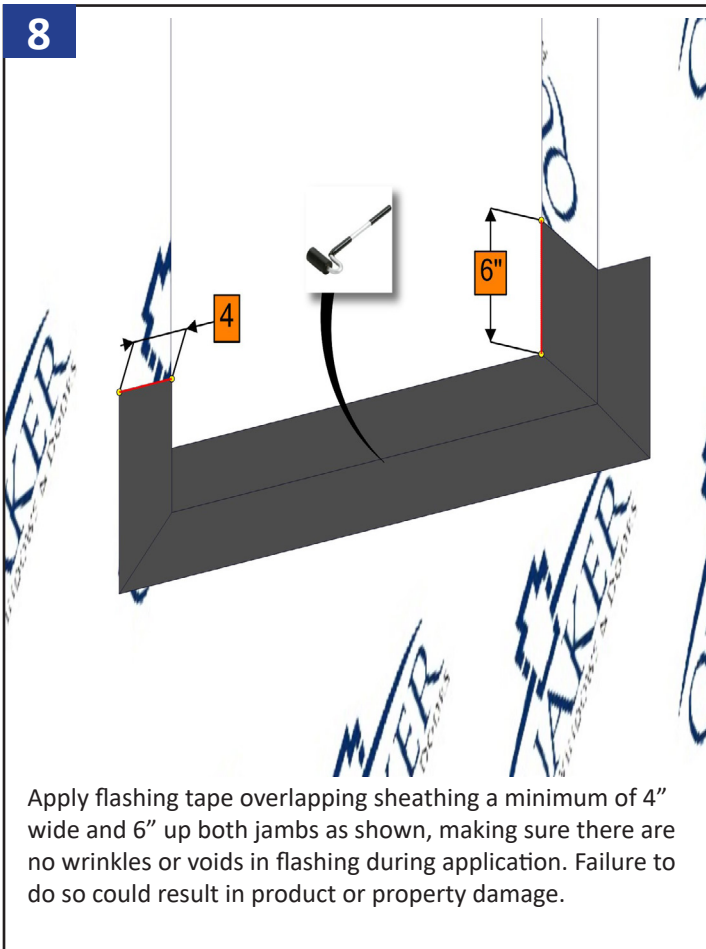

12



Temporarily fasten with a single fastener at the top of one jamb side as shown.

13



Shim at the sides of the window, and at the check rail locations. Never shim at the head.

14

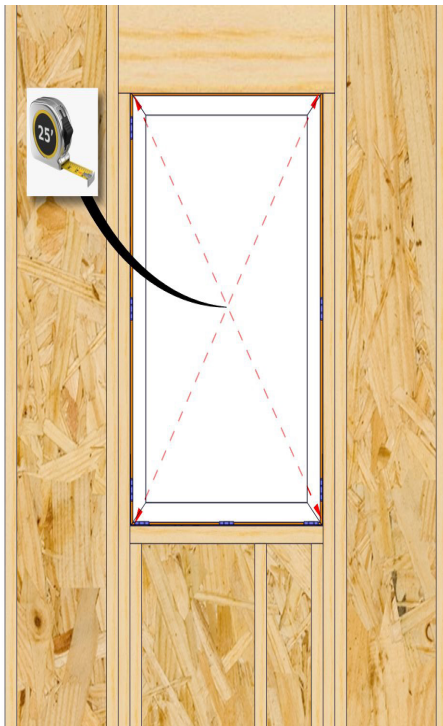

Check that the window is square. Adjust shims as needed to assure unit diagonal measurements are within 1/8".

15

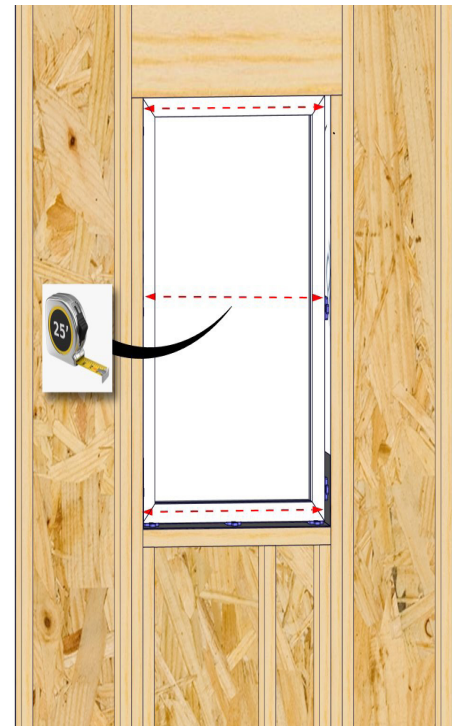

Check that the window is not bowed. Adjust shims as needed unit measurements are within 1/8".

16

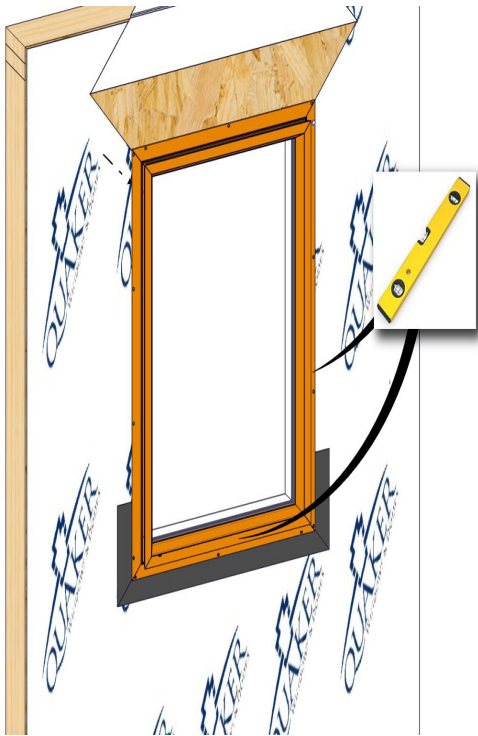

Check that the frame is plumb and level. Adjust shims as needed.

17

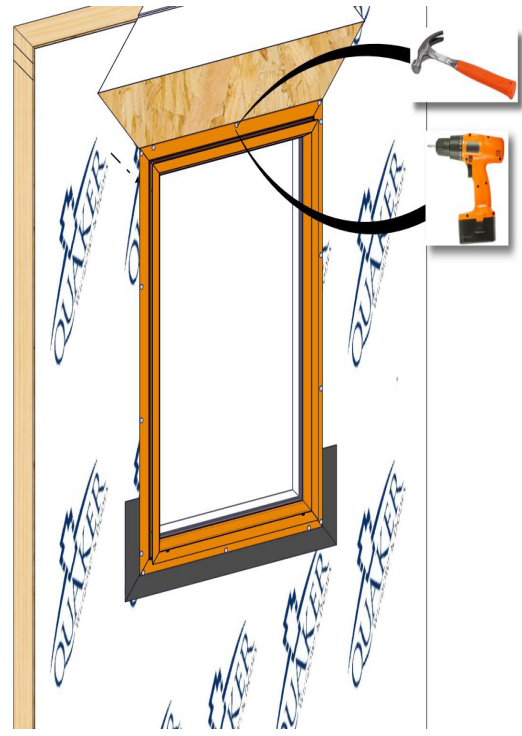

Finish fastening the unit using every hole or a minimum of 12" on center.

18



Apply the head flashing to the top edge of window as shown below.

19

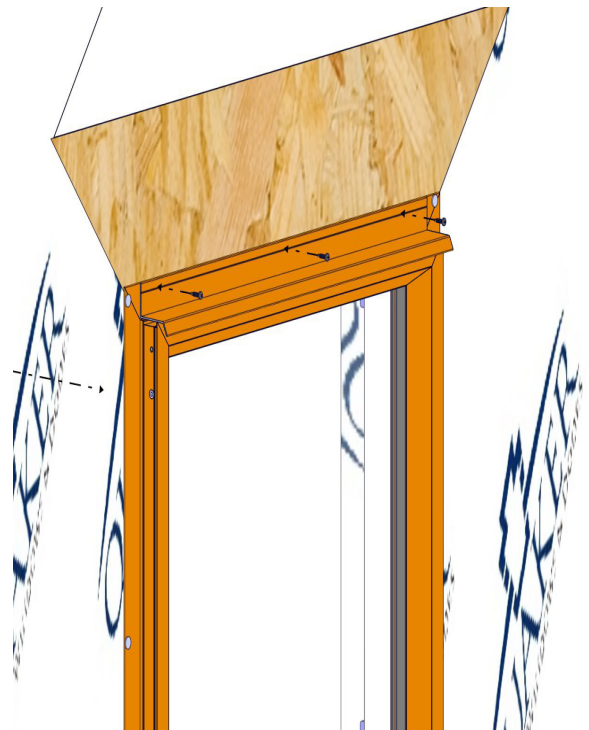

Fasten the head flashing with small self tapping screws. Make sure the head flashing is setting down tight on the window frame.

20

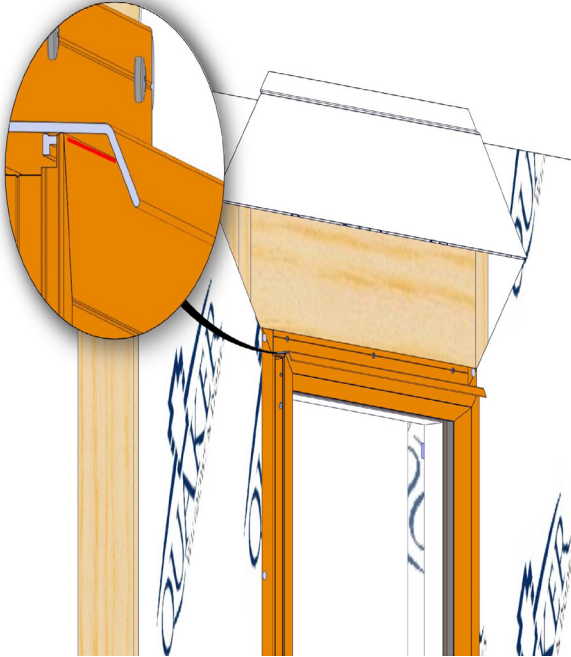

Caulk the seam between the bottom of the head flashing and top of the window.

21

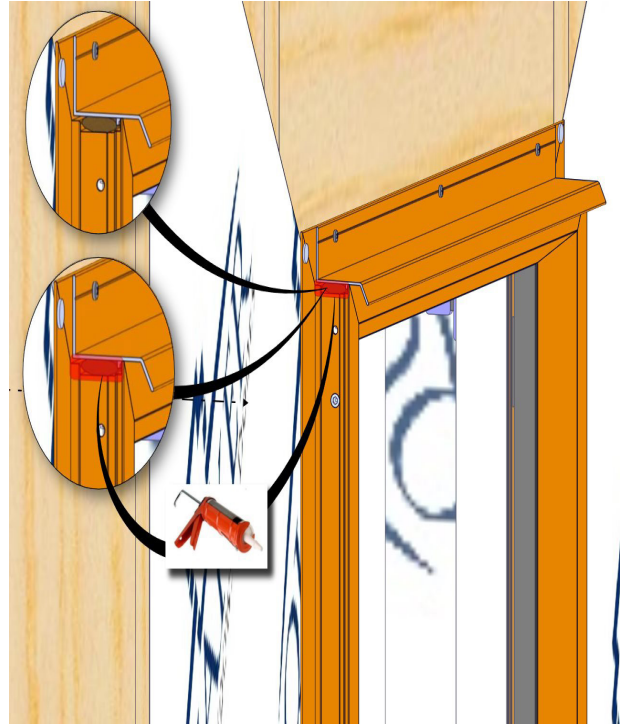

Use backer rod and sealant to seal both ends of the head flashing and window as shown above.

22



Apply the sill flashing to the bottom edge of window as shown above.

23

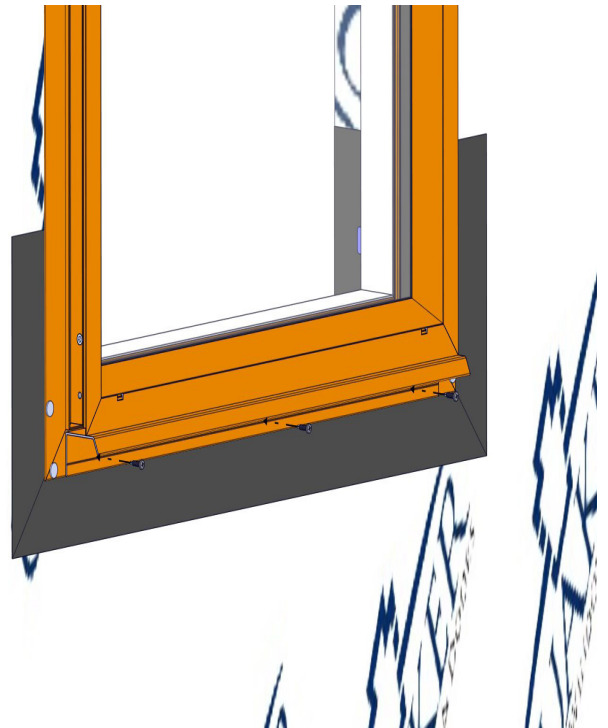

Fasten the sill flashing tight against the bottom of the window with self tapping screws as shown above.

24

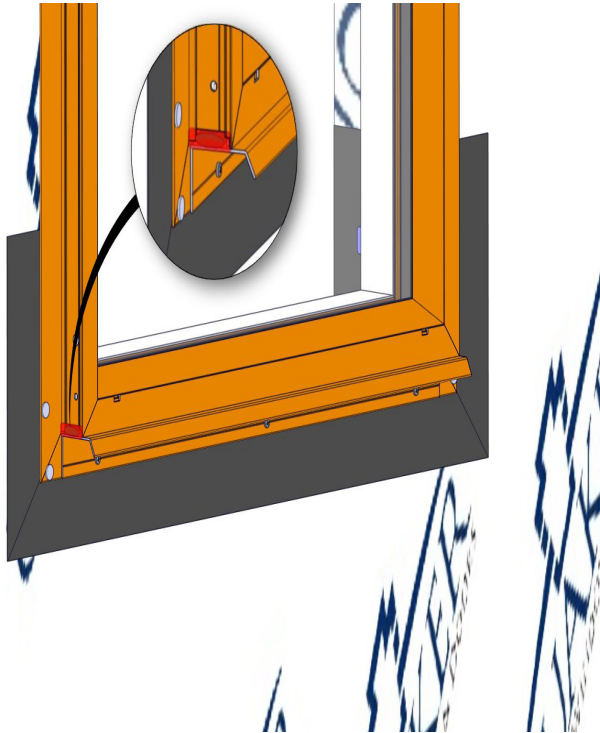

Apply backer rod and sealant to both ends of the sill flashing to seal it against the window as shown above.

25

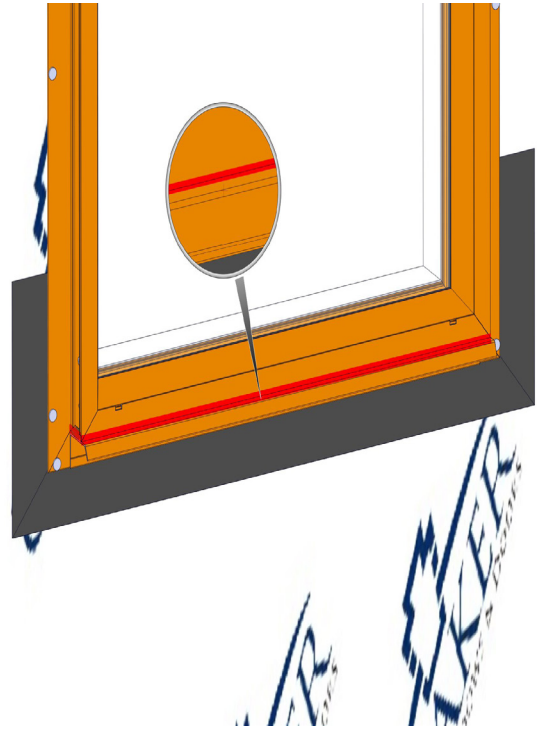

Apply a continuous cap bead of sealant between the sill flashing and the window as shown above.

26

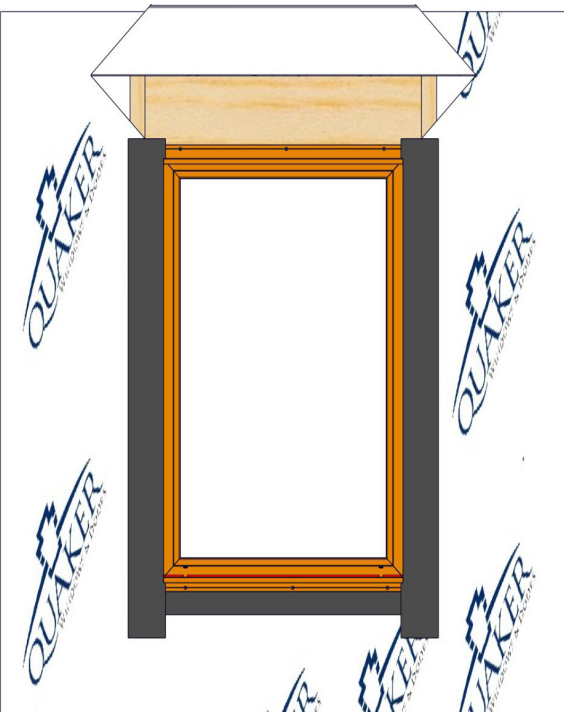

Apply flashing tape at the sides of the window, overlapping the sill flashing as shown covering all gaps in nail fin corners. Smooth using a J-roller. Extend tape a minimum of 2" past the window nail fin at the head.
*Make sure flashing tape comes to the main frame of the window

27

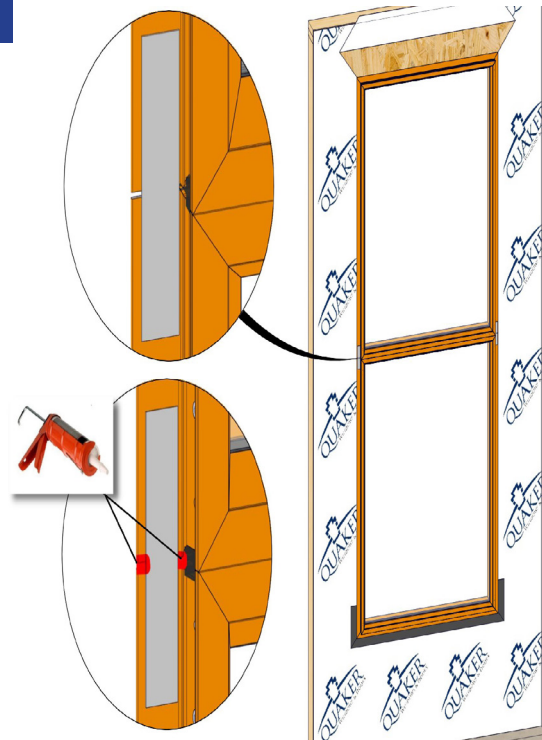

For Mullioned Units:

Nailing fins on each unit should have a cover that bridges the gaps and be sealed coming from the factory. Seal any gaps that remain between fins or at the window joints and tool in smooth. Repeat for the other side of the units.

28

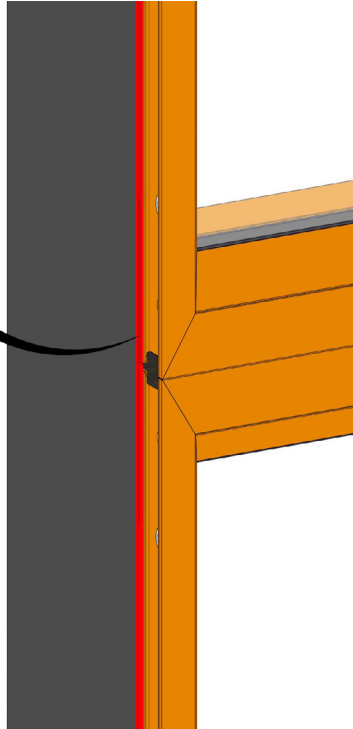

For Muller Units:

Apply flashing tape as described in Step 26. Then add a continuous bead of sealant between the flashing tape and main frame and tool smooth. Verify no gaps remain between tape and main frames.

29

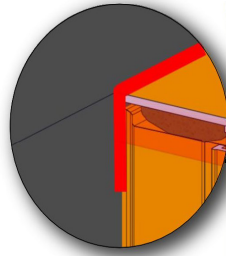

Apply flashing tape over the head flashing, overlapping the side flashing as shown, covering any seam or gap in the nailing fin at the corners. Smooth using a J-roller. Put sealant at top corners of flashing tape.



Side flashing cannot extend above the top flashing. Doing so could result in product or property damage.

30

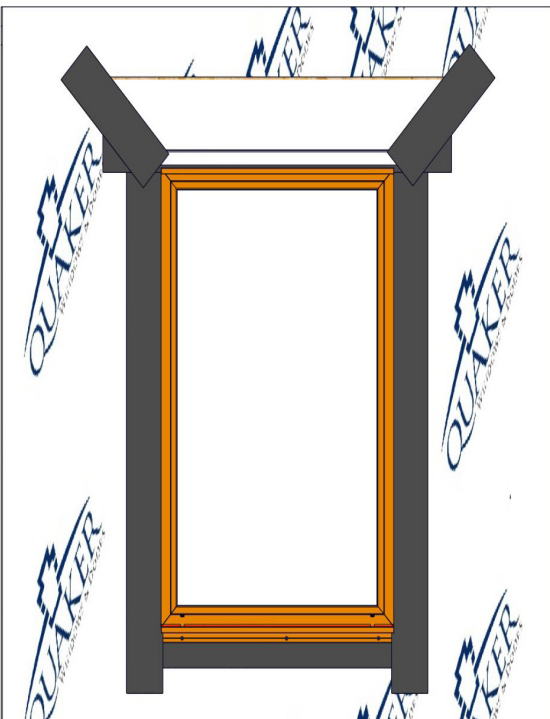

Unfold the house wrap top flap and tape the angled seams as shown above.

31



Fill interior 1/3 of the cavity using low expanding foam or loose insulation.

32

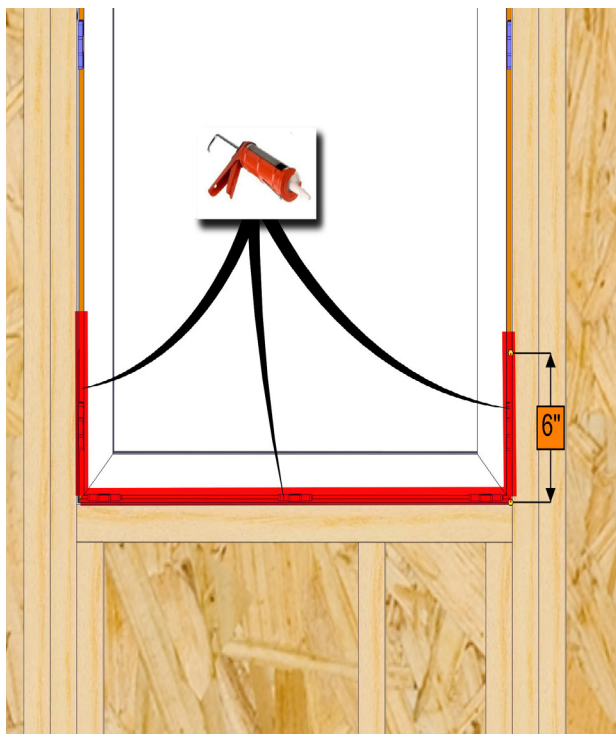

Apply a continuous cap bead of sealant across the entire bottom and up 6" both sides of the window unit on the interior side.